

WALLACH®

product guide

Innovative surgical products designed to meet the demanding diagnostic and therapeutic requirements of today's obstetrics, gynecology and infertility practice.



ISO 13485
CERTIFIED

www.wallachsurgical.com

WALLACH

Your source for women's healthcare

Dear Valued Customer:

Wallach Surgical Devices is leading the way in introducing new technology for the OB/GYN and strengthening its commitment to providing safe, economical medical devices of the highest quality. Our business was built on the principles of Quality, Dependability, Innovation, Affordability and Customer Service. We are excited to be expanding our line of quality products.

Our state-of-the-art Trulight™ LED lighting system is now being added to our colposcopes. All Trulight colposcopes come with a seven warranty, the first of its kind in the industry. Trulight offers a brighter, whiter, cooler light.....never change a light bulb again during a procedure!

Total Recall Digital Imaging Software now incorporates new digital technology capability. Our new USB digital camera can be easily integrated into your PC or laptop. The high quality images you need can now be integrated into EMR systems.

New Obstetric Archiving software is ideal for use in your busy obstetrics practice. Data received from fetal monitors can be viewed, documented and archived in an easy to use, paperless user interface with the Sonicaid Team™ Fetal Monitor.

If you haven't already done so, try Wallach's established disposable brands like Papette® Cervical Cell Collector, the first choice for conventional and fluid based pap smear technology. Endocell™ Endometrial Cell Samplers offer simple, non-traumatic testing for endometrial screening extracting a histological sample from the uterine mucosal lining in seconds. Our popular plastic, malleable Flexisound™ Intrauterine Sounds are marked in centimeters and so gentle, we're sure you will agree that nothing compares.

Remember, in the women's healthcare field, the Wallach name is the one physicians trust. Satisfied customers are our most valuable asset. Please call our customer service department to learn more about the Wallach family of products and how we can be of service

Sincerely,
The Wallach Team



1-800-243-2463
www.wallachsurgical.com

Colposcopes	2 - 7
Cryosurgery	8 - 9
Electrosurgery	10-13
Coated Instruments Specula	14-15
Specula	16-17
Biopsy Instruments	18 -21
Uncoated Instruments	22 - 23
Office Instruments	24
Single Use Products	25-27
Bone Densitometry	28-29
Fetal Monitors	30-31
Fetal Doppler	32
Dermatologic Cryosurgery	33
Warranty Information	34
Return Goods Policy	34
Repair Policy	34
Index	35

Nothing works like a **Wallach**



Trulight™ Technology



Wallach's premier colposcope is now available with the latest state-of-the-art LED lighting system...Trulight. The whiter, brighter light makes viewing easier than ever.

ZoomScope's unique overhead suspension arm allows for optimal viewing of the examination site with unobstructed access. Quality stereoscopic Nikon optics offer the utmost in flexibility and precision. The infinitely zooming optics allow precise focus on areas of interest. This guarantees the largest image at the highest magnification. Now the ZoomScope is available with USB camera video option which allows high quality images to be integrated into EMR systems. Optional foot pedal control for power zoom and focus frees both hands for positioning instruments and completing the procedure without disturbing the patient.

REF 906043-SP-3	ZoomScope Trulight Quantum Series (also available with 4 or 5 leg base)
906043-40TU-5	ZoomScope Trulight with Video (USB)
906043-70TU-5	ZoomScope Trulight with Video, Power Zoom and Focus (USB)
906043-3	ZoomScope traditional halogen light* (also available with 4 or 5 leg base)

*3 year warranty
(for other colposcope configurations, please call customer service)

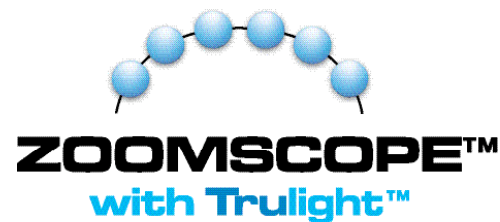

Wallach's revolutionary new Trulight lighting system incorporates five high intensity, long life light emitting diodes (LEDs) designed around the objective lens. The white solid state LEDs provide light at 5000-6000K (brighter white). Precisely angled, the lights converge to the target offering a brighter, white light for true tissue color. The center light is green and can be turned on at the touch of a switch for delineation of vascular patterns. The LEDs eliminate the need to change light bulbs!

- 5 solid state LEDs
- Lights converge on target
- Brighter, white light
- No need to change a light bulb
- 7 Year Warranty

All Trulight Colposcopes come with a 7 Year Warranty

"I love the new ZoomScope™ with Trulight which has a superior, brighter cool LED light source, a great advantage when performing colposcopy. There is never a bulb to change during a procedure. Together with superior optics and ease of focusing, Trulight offers a winning combination. There is no other colposcope that even comes close!"



Ruth Steinberg, M.D.
New York City



ZoomStar™ offers the same quality optics and features as ZoomScope™ on a compact center stand, where space and/or budget is a concern. Also available with USB camera video option.

REF 906057T	ZoomStar with Trulight
906057-40TU	ZoomStar Trulight with Video (USB)

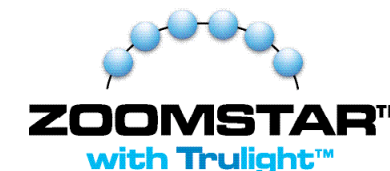

Multi-Step Magnification Colposcopes

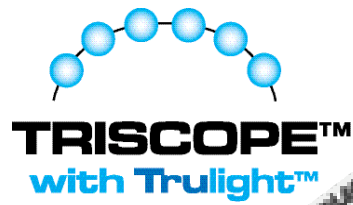

TriScope™/PentaScope™
3 and 5 step magnification colposcopes
with overhead suspension arm

- Magnification of 4x, 6x, 10x, 16x and 25x for 5-step PentaScope
- Magnification of 8x, 13x and 21x for 3-step TriScope
- Trulight for brighter, whiter light

Wallach's highly versatile Tri/Penta series of colposcopes offer an optical pathway for a direct view. This family of multi-step magnification colposcopes features a built-in dual optical beamsplitter which permits attachment of digital photographic accessories, video and co-observation teaching tube. The colposcopes deliver the 3D image needed to detect subtle tissue abnormalities and to perform colposcopically directed biopsies and surgery with optimum hand/eye coordination. Wallach's unique overhead suspension arm is included for solid, yet easily adjustable operation. The result is total stability through the full range of motion. Also, available with traditional halogen lighting.

REF 906150T-4	TriScope Trulight colposcope with 4 leg base
REF 906150T-5	TriScope Trulight colposcope with 5 leg base
REF 906152T-4	PentaScope Trulight colposcope with 4 leg base
REF 906152T-5	PentaScope Trulight colposcope with 5 leg base
REF 906150-4	TriScope traditional halogen light colposcope with 4 leg base
REF 906150-5	TriScope traditional halogen light colposcope with 5 leg base
REF 906152-4	PentaScope tradition halogen light colposcope with 4 leg base
REF 906152-5	PentaScope tradition halogen light colposcope with 5 leg base



Tri/Penta Star with digital USB video camera.



Tri/Penta Star with digital camera.

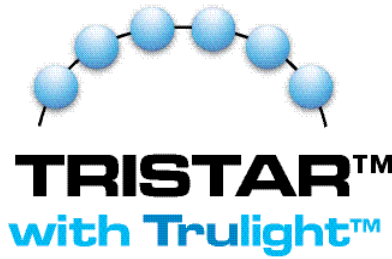

REF 906140T	TriStar Trulight colposcope
REF 906151T	PentaStar Trulight colposcope
REF 906140	TriStar traditional halogen
REF 906151	PentaStar traditional halogen
ACCESSORIES	
REF 900832	Tri/Penta colposcope Digital Package – high resolution digital camera (SLR), adaptor lens, printer.
REF 90081 IU	Digital USB based video camera for Tri/Penta colposcopes
REF 900813	Teaching Tube for Tri/Penta colposcopes

ColpoStar™ IH

affordable, high quality single magnification

Unique to single magnification colposcopes is ColpoStar's fiber optic halogen lighting system which yields white, clear, cool, natural tone tissue illumination for accurate colposcopic examination. ColpoStar IH offers precision, distortion-free stereo optics, optimum single magnification, wide field of view and great depth-of-field. This colposcope features a compact center post with fine and coarse height adjustment, and a five-point base for stability and maneuverability between examination areas.

- Magnification: 12x
- Working distance: 300mm
- Precision, distortion-free optics

REF 906135 ColpoStar IH



NOW with
Trulight Technology!
7 year Warranty. Never
change a light bulb again
during a procedure!



TriStar™/PentaStar™ 3 and 5 step
magnification colposcopes on a center
post stand

Total Recall™ Digital Colposcopic System

View, document and manage colposcopic examinations

Shown with
ZoomScope Trulight
Colposcope



Total Recall digital patient management software offers patient tracking, measurement of disease progress and treatment in one easy to use operational package. The system can be added to any Wallach zoom and multi-step magnification video colposcope for a flexible, all-inclusive operational package. Optional power zoom and focus enable hands free operation of the colposcope. The software may be purchased preloaded on a laptop which can be positioned on the colposcope shelf for convenience or is available for purchase separately to add to your own laptop.

- Real-time viewing
- Image storage
- Mark and measurement recording
- Compare images
- Store image annotations
- Track history, past tests and treatments
- Communicate and consult
- Password protected files
- EMR image transfer capability
- Choose from a variety of colposcopes

TOTAL RECALL™

ZOOMSCOPE™
with Trulight™

Total Recall is available
on all Wallach zoom and
multi-step magnification
colposcopes.



NEW

Introducing Trulight™ a
brighter, whiter, cool LED
light for all Wallach zoom
and multi-step magnification
colposcopes.

*Never change a light bulb
again during a procedure.*

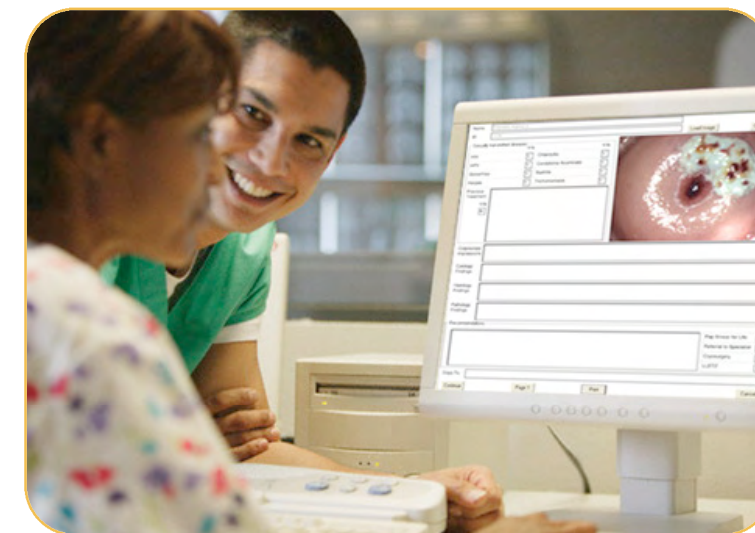

Patient Information		Exam Date	12/21/2007	
Name	Magnum, Martha G.	Birth Date	11/23/1978	
ID	1234	Age	29	
Physician	Dr. Bowen			
Performed By	Edward Carol, M.D.			
Special Considerations				
History	Name Text Test 1			
Reason for visit	ID	6552555	Load Image Clear Image	
Allergies and Medications	Sexually transmitted diseases			
Pap Smear Results	HIV	<input type="checkbox"/>	Chlamydia	<input type="checkbox"/>
Last Pap smear	HPV	<input type="checkbox"/>	Condyloa Acuminata	<input type="checkbox"/>
Prepregnant (weeks)	Gonorrhea	<input type="checkbox"/>	Syphilis	<input type="checkbox"/>
	Herpes	<input type="checkbox"/>	Trichomoniasis	<input type="checkbox"/>
	Previous Treatment	<input type="checkbox"/>		
Risks				
Personal History	Colposcopy Impressions			
Family History	Cytology Findings			
History of genital	Histology Findings			
History of sexual	Pathology Findings			
Vaginal defects?				
Comments	Recommendations			
Page 2				
			Pap Smear for Life <input type="checkbox"/>	
			Referral to Specialist <input type="checkbox"/>	
			Cryosurgery <input type="checkbox"/>	
			LLETZ <input type="checkbox"/>	
	Copy To:			
	Continue	Page 1	Print	
			Cancel	

REF 906043-40TU-5 ZoomScope Trulight with Video, Digital USB Camera

REF 906043-70TU-5 ZoomScope Trulight with Video, Power Zoom and Focus,
Digital USB Camera

REF 910000LU Laptop computer with Total Recall (with arm/shelf)

REF 910016U Laptop Computer with Total Recall

REF 910015U Total Recall (software only)

REF 910013L Arm/Shelf Assembly for Laptop (for 5 leg base)

LL100™ Cryosurgical System

Gives physicians the fastest freeze and defrost



Wallach's exclusive two-trigger design lets the physician precisely control both freeze and defrost. With twice the freeze power of other systems, the LL100 performs both functions more effectively in less time eliminating treatment failures. Freeze and defrost only occur when triggered. Light weight, well-balanced and maneuverable – provides full view of the target tissue. The gas hose allows for unimpeded surgical movement. Cryotips can be changed at any time without venting. A large selection of highly conductive reusable, sterilizable cryotips and disposable plastic shields are available.

REF900001A-N2O	LL100 Cryosurgical Freezer N2O plus three tips (T-1905, T-2514, T-0500)	REF900002	LL100 Cryosurgical Freezer CO2
REF 900002A-CO2	LL100 Cryosurgical Freezer CO2 plus three tips (T-1905, T-2514, T-0500)	REF900020	LL100 Short Shaft Cryosurgical Freezer N2O
REF900001F-N2O	LL100 Cryosurgical Freezer N2O plus three tips (T-0524, T-0219, T-1900)	REF900034	LL100 Short Shaft Cryosurgical Freezer CO2
REF900002F-CO2	LL100 Cryosurgical Freezer CO2 plus three tips (T-0524, T-0219, T-1900)	REF901060	N2O Cylinder (unfilled)
REF900001	LL100 Cryosurgical Freezer N2O	REF901061	CO2 Cylinder (unfilled)
		REF901011	Cart for 20 lb. Cylinder

WA1000B™ Cryosurgical Console System

High performance features and professional appearance make the WA1000B your best choice

The WA1000B console offers the ideal combination of easy-to-use controls and built-in safety features. It uses the powerful LL100 two-trigger freezer. The Temperature Indicator with integrated timer gives physicians precise documentation during cryosurgery. The cart can carry a single 20 lb. cylinder.

REF900506-1-N2O	WA1000B Cryosurgical System, Blank Console, Base and LL100 Freezer (N2O)
REF900506-1-CO2	WA1000B Cryosurgical System, Blank Console, Base and LL100 Freezer (CO2)
REF900506-2-N2O	WA1000B Cryosurgical System with Digital Temp. Indicator, Timer, Base and LL100 (N2O)
REF900506-2-CO2	WA1000B Cryosurgical System with Digital Temp. Indicator, Timer, Base and LL100 (CO2)

*see Warranty Policy on page 32



Cryosurgical Tips

Highly conductive, thermal, reusable, sterilizable cryotips with disposable plastic shields

- Utilized by LL100 and WA1000B Cryosurgical Systems
- Ultimate in safety and convenience
- Each tip is supplied with 5 single-use, disposable plastic shields
- Remove disposable shield from cryotip and discard after each use (shields insulate the tip and assure proper attachment)
- Cryotip is fully sterilizable to prevent cross-contamination

2.5mm HPV Tip (T-0200) REF 900300AA	Flat (T-2500) REF 900213AA	General Purpose (T-0819) REF 900205AA
5.0mm HPV Tip (T-0500) REF 900301AA	Exocervical (T-1905) REF 900209AA	Procto (T-0832) REF 900204AA
7.0mm HPV Tip (T-0700) REF 900302AA	Exo-Endocervical (T-1910) REF 900211AA	Procto Curved (T-0832) REF 900217AA
9.0mm HPV Tip (T-0900) REF 900303AA	Long Exo-Endocervical (T-1920) REF 900212AA	Bevel (T-0524) REF 900202AA
11.7mm HPV Tip (T-1200) REF 900304AA	Exo-Endocervical (T-1920) REF 900210AA	Bevel (T-0823) REF 900207AA
13.5mm HPV Tip (T-1300) REF 900305AA	Exocervical (T-2507) REF 900214AA	Cone (T-0219) REF 900201AA
15.0mm HPV Tip (T-1500) REF 900306AA	Exo-Endocervical (T-2514) REF 900215AA	Microderm (T0219) REF 900200AA
Flat (T-1900) REF 900208AA	Condyloma (T-0519) REF 900203AA	Cone (T0826) REF 900206AA

REF 900221AA (Bag of 100)
Disposable Plastic Shields



Quantum 2000™ Electrosurgical System

Including Biovac Smoke Evacuator and Integration Unit



Loop electrosurgery has never been more convenient, safe, dependable and affordable.

Wallach's exclusive, state-of-the-art microprocessor offers the latest in technology. The system constantly and accurately monitors power levels for smoother, drag free cuts. High impedance tissue can be excised without bending the electrode. There's minimal thermal damage; therefore, a superior histological specimen for pathology can be obtained. Post excision, the coagulation mode supplies powerful spray fulguration that can seal bleeders without tissue contact.

- Solid state, isolated circuitry generator
- Footswitch or handswitch operated
- Audible alarm for safety
- Return electrode monitoring type system uses split grounding pad for extra safety
- Automatically and instantly activates the Biovac

Fully integrated system

Biovac™ Smoke Evacuator

designed to complement the Quantum 2000 Electrosurgical Generator

- Efficiently removes airborne vapor containing potentially harmful microbes and viruses
- Features a quiet, high-powered motor and a disposable, one-piece filter that stops particles down to 0.02 microns
- Adjustable handle
- Compatible with any other electrosurgical, laser or electrocautery unit



REF 909075	Quantum 2000 Electrosurgical Generator
REF 909077A	Quantum 2000 Electrosurgical Generator with Biovac Smoke Evacuator and Integration Unit plus Starter Kit
REF 909070	Biovac Smoke Evacuator
REF 909080	Integration Unit

To order, call • 1-800-243-2463 • www.wallachsurgical.com

Disposable Loop Electrodes (ER series)

Wallach offers a wide variety of disposable, extra rigid loop and ball electrodes to meet any need

Wallach's disposable, **extra rigid** loop and ball electrodes come in a single, sterile package with five packages to a box. The extra rigid series is designed to prevent undesirable bending while cutting. A variety of loops, squares and balls are available in high quality tungsten wire.

Unless otherwise specified, all shaft lengths are 13 cm.

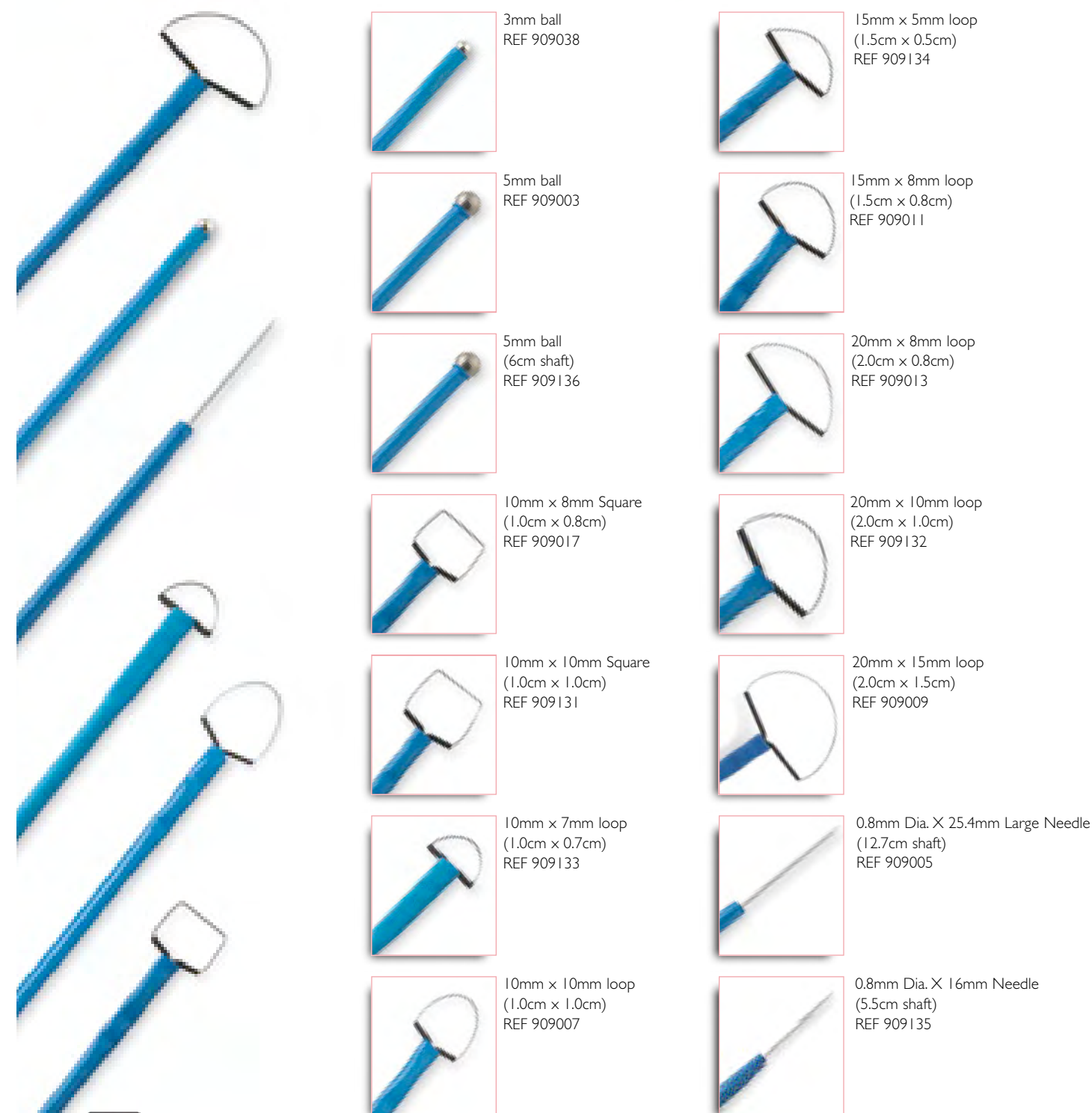

To order, call • 1-800-243-2463 • www.wallachsurgical.com

Electrosurgical Accessories

Footpedal-operated Pencils

For use with Quantum 2000 and other compatible electrosurgical generators. Sterile and single-use only. Reusable adaptor required. Can be used with any standard disposable electrodes.

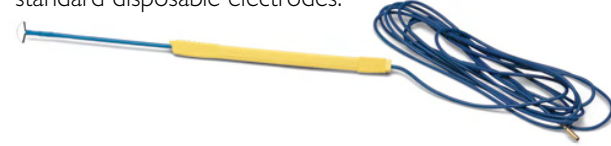

REF 909028 **Footpedal-Operated Pencils, Sterile** (25 pack)
REF 909032 **Adaptor for Footpedal-Operated Pencil**

Disposable Patient Split Grounding Pads (with connect)

For use with Quantum 2000, these pads offer extra patient safety by signaling the system to shut down if the patient is not in complete contact with the pad.

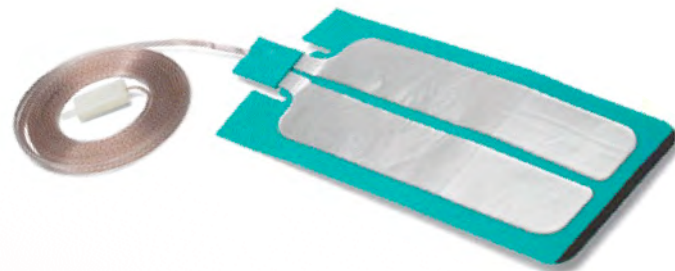

REF 909078 **Disposable Patient Split Grounding Pads with connect** (10 pack)

Endocervical Block Kit (for intra cervical block)

This kit is sterile, single-use only. It includes the reinforced, long EndoBlock needle, 18 gauge needle for drawing anesthetic and disposable syringe with finger grip. Buy EndoBlock needles separately in a 6 pack box with either luer lock or threaded hub.



REF 920009 **Endocervical Block Kit** (10 pack)

Handswitch-operated Pencils

For use with Quantum 2000 and other compatible electrosurgical generators. Sterile and single-use only. Convenient cut and coag push buttons.



REF 909089 **Handswitch-Operated Pencils, Sterile** (25 pack)

Electrosurgical Disposable Grounding Pads (for use with reusable cable)

Universal electrosurgical split grounding pad for use with Quantum 2000 and other competitors' units. Must be used with durable, reusable 9 ft. 4 in. cable that can be disinfected after each use. This method is cost-effective.



REF 909152 **Electrosurgical Disposable Grounding Pads for use with reusable Cable** (box of 50)
REF 909153 **Reusable Cable**

EndoBlock™ Needle (for intra cervical block)

- Sterile, single-use only
- Reinforced and extended shaft for distance and tough cervical tissue
- Threaded hub needle for dental style cartridge syringe
- Luer Lock for use with your medical syringe

REF 920017 **EndoBlock Needle Luer Lock** (6 per box; sterile)
REF 920017-1 **EndoBlock Needle Luer Lock** (60 pieces; sterile)
REF 920021 **EndoBlock Needle Threaded Hub** (6 per box; sterile)



Ferric Subulfate Aqueous Solution

Make post-operative bleeding easier to control. Twelve single-dose bottles come in a convenient box.

REF 909084 **Ferric Subulfate Aqueous Solution** (12 pack)
REF 909086 **Ferric Subulfate Aqueous Solution** (60 bottles)



QKIT Procedure Tray for Loop Electrosurgical Excision Procedure

Disposable procedure trays for LEEP procedure. Each kit contains everything needed to perform the LEEP procedure in one convenient location: Two cartridges lidocaine with and two without epinephrine; one Ferric Subulfate Aqueous Solution 8 gm bottle; one reinforced 27 gauge, 3 1/2" long needle with threaded hub; one alcohol wipe; six jumbo cotton swabs; one underpad; one pantyliner.

REF 909072 **QKIT Procedure Tray** (5 kits)
REF 909073 **QKIT Procedure Tray** (20 kits)

Dental Style Cartridge Syringe

Reusable syringe accepts lidocaine cartridges for quick and easy anesthetic blocks.



REF 909171 **Dental Style Cartridge Syringe**



Disposable Smoke Evacuation Speculum Tubing (Non-Sterile)

Slides through slot of compatible speculums and attaches to flexible smoke evacuation tubing.

REF 920001 **Disposable Speculum Tubing** (50 per box)

Smoke Evacuator Filter Assembly



Filter and evacuation tubing efficiently removes airborne vapor containing potentially harmful microbes. Maximum operating time 30 minutes.

REF 909094 **Smoke Evacuator Filter Assembly** (5 pack)

Disposable Smoke Evacuation Tubing with Attached Speculum Tubing

Six-foot-long sterile, single-use only smoke evacuation tubing with attached speculum tubing connects to the smoke evacuator filter assembly.

REF 920002 **Disposable Smoke Evacuation Tubing with Speculum Tubing** (10 per box)



Electrosurgical Instruments

Coated Gyn Hook

Most popular hook. Sharp and strong for maximum grip.
REF 907020

Coated Gyn Hook

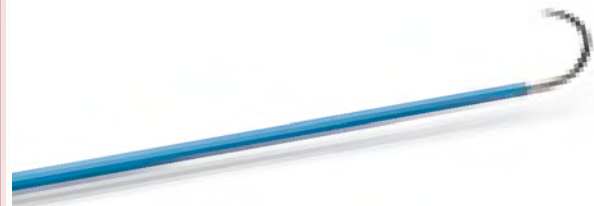

LEEP Hook Straight

Small hook designed for stabilization of tissue during excision.

REF 909160

LEEP Hook Straight

REF 909170

LEEP Hook Angled 9.5" Left

REF 909172

LEEP Hook Angled 9.5" Right



LEEP Two Prong Hook (Length: 26cm)

Designed with twin prongs to allow enhanced grasping and manipulation ability of the cervix while spacing ensures unrestricted electrode access to the operative site.

REF 909162

LEEP Two Prong Hook



LEEP Three Prong Hook (Length: 26cm)

Designed for optimal manipulation and stabilization of the cervix while allowing maximum electrode access.

REF 909164

LEEP Three Prong Hook



LEEP Iris Hook (Length: 25cm)

Small hook designed to stabilize tissue during excision.
REF 909166

LEEP Iris Hook



LEEP Campion Forceps (Length: 22cm)

Designed as an angled forceps for better visualization of tissue being removed from operative site.

REF 909161

LEEP Campion Forceps



LEEP Ring Forceps (Length: 22cm)

Larger forceps designed to remove tissue sample excised during the LEEP procedure.

REF 909163

LEEP Ring Forceps



LEEP Single Tooth Tenaculum (Length: 24cm)

Popular instrument offering optimal stabilization of the surgical site.

REF 909167

LEEP Single Tooth Tenaculum



LEEP Tissue Forceps (Length: 21cm)

Simple forceps perfect for grasping and removing tissue. Coated surface offers safety and convenience.

REF 909165

LEEP Tissue Forceps



Coated Specula

Ultimate Reusable Specula

Try our new lightweight, smooth reusable speculum made from specialized polymer for ultimate patient comfort. Fully autoclavable and easy to care for, this speculum is non-conductive for use during electrosurgery. Accidental scratching of the solid polymer cannot result in a patient burn.

REF 909100

Ultimate Reusable Speculum

Lateral Vaginal Wall Retractor

Designed to fit into a standard speculum, this retractor holds the vaginal walls to permit exposure of the cervix.

REF 909069

Lateral Vaginal Wall Retractor

Leep Endocervical Speculum

This endocervical speculum provides access to the cervical canal or the os.

REF 909168

LEEP Endocervical Speculum – Regular (Tip Size: 6mm)

REF 909169

LEEP Endocervical Speculum – Medium (Tip Size: 5mm)

Graves Specula

Standard Graves speculum features a guide for disposable smoke tubes for easy cleaning of the speculum. Non-conductive coating for added safety.

Autoclavable.

REF 903017

LLETZ Graves Speculum – Medium w/DSE Guide

REF 903018

LLETZ Graves Speculum – Large w/DSE Guide

Pederson Specula

Specially designed for electrosurgical procedures. The blades are narrow and thus more comfortable for those with a narrow vaginal canal. DSE tubing guide included.

REF 903019

LLETZ Pederson Vaginal Speculum – Small w/DSE Guide

REF 903020

LLETZ Pederson Vaginal Speculum – Medium w/DSE Guide

REF 903021

LLETZ Pederson Vaginal Speculum – Large w/DSE Guide

View-More Specula

Allows easier access and enhances the physician's view. This speculum has a wide opening to accommodate the lateral vaginal wall retractor. Autoclavable.

REF 903022

LLETZ View-More Speculum – Medium w/DSE Guide

REF 903023

LLETZ View-More Speculum – Large w/DSE Guide

View-Maxi Specula

This speculum has an extra-wide opening with a rectangular yoke for easier access of instruments and for better viewing by the physician.

REF 903024

LLETZ View-Maxi Pederson – Medium w/DSE Guide

REF 903025

LLETZ View-Maxi Pederson – Large w/DSE Guide

REF 903030

LLETZ View-Maxi Graves – Medium w/DSE Guide

Omni 4-Blade Specula

Combines speculum with lateral wall retractor. Ideal for patients with collapsed vaginal wall. Especially designed for large and multiparous patients.

REF 903026

LLETZ Omni Speculum – Medium 4-Blade w/DSE Guide

REF 903027

LLETZ Omni Speculum – Large 4-Blade w/DSE Guide

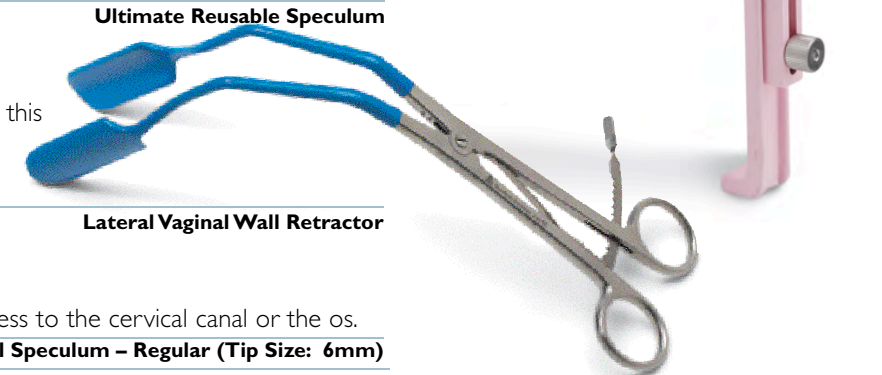

4 blade style for electrosurgery

Specula Dimensions

Graves, Weisman-Graves, View-More and View-Maxi

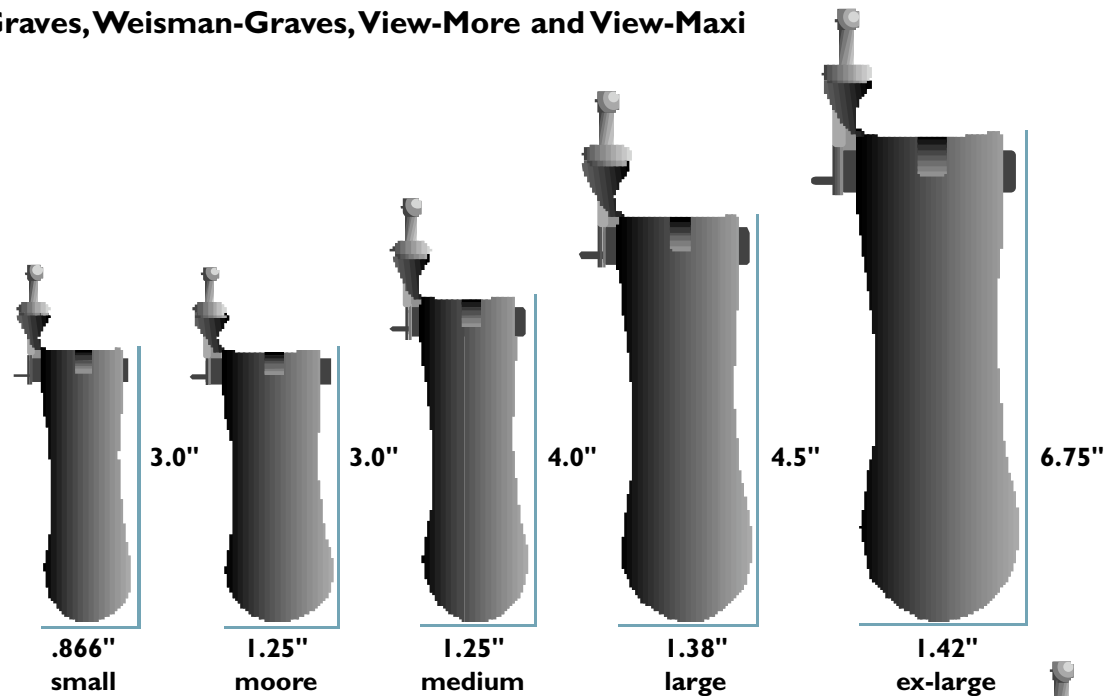

Pederson and View-Maxi

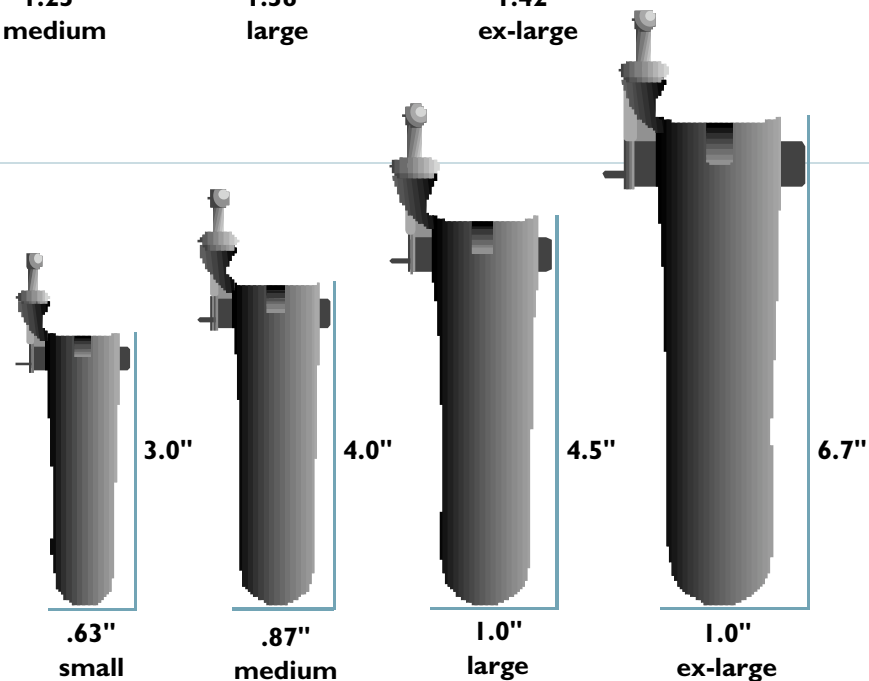

Yoke Dimensions

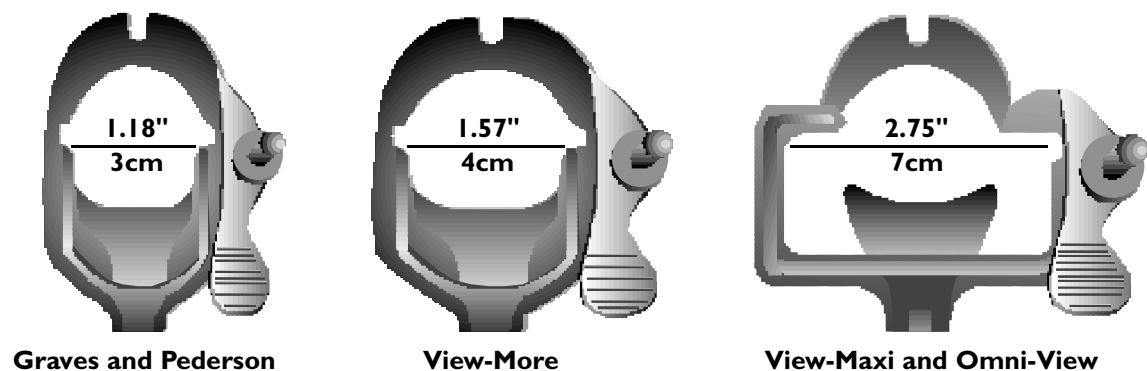

Uncoated Specula

Designed to fit into a standard speculum, this lateral wall retractor offers an enhanced view of the cervix.

REF 907043 **Lateral Retractor View-More Opening, Uncoated**

Standard ratchet handle. Choose from standard or narrow tip to suit your patient needs.

REF 907010 **Kogan Endocervical Speculum**

REF 907015 **Kogan Endocervical Speculum, Narrow**

Traditional design with slightly wider blades.

REF 903001 **Graves Vaginal Speculum, Small**

REF 903002 **Graves Vaginal Speculum, Medium**

REF 903003 **Graves Vaginal Speculum, Large**

REF 903004 **Graves Vaginal Speculum, Ex-Large**

Unique speculum featuring short blades with the same width of a medium Graves.

REF 903005 **Moore Graves Speculum**

Thinner blade design.

REF 903006 **Pederson Vaginal Speculum, Ex-Small**

REF 903007 **Pederson Vaginal Speculum, Ex-Narrow**

REF 903008 **Pederson Vaginal Speculum, Small**

REF 903009 **Pederson Vaginal Speculum, Medium**

REF 903010 **Pederson Vaginal Speculum, Large**

REF 903011 **Pederson Vaginal Speculum, Ex-Large**

Open-sided speculum with one-sided hinge offers easier access of instrumentation.

REF 903012 **Weisman Graves Speculum, Right Medium**

REF 903013 **Weisman Graves Speculum, Left Medium**

Provides more viewing room at the yoke and allows for easier instrumentation.

REF 903014 **View-More Vaginal Speculum, Medium**

REF 903015 **View-More Vaginal Speculum, Large**

Extra wide rectangular yoke for enhanced viewing and easier access.

REF 903016 **View-Maxi Graves Speculum, Medium**

Offers narrower blades combined with lateral blades that lock in place for better visualization.

REF 903028 **Omni Speculum, Medium 4 Blade**

REF 903029 **Omni Speculum, Large 4 Blade**



Biopsy Punches

High quality German stainless steel from a name you know and trust

Standard Tischler design for minimal discomfort and trauma. Spring handle design handcrafted with precision in German stainless steel.

REF 907008 **Tischler Cervical Biopsy Punch Forceps (7mm x 3mm) (20cm)**

REF 907054 **Tischler Punch (7mm x 3mm) (25cm)**



REF 907008

Popular small tip rectangular biopsy forceps offers smaller samples with minimal discomfort.

REF 907014 **Baby Tischler Biopsy Forceps (4.2mm x 2.3mm) (20cm)**

REF 907058 **Mini Tischler (4.2mm x 2.3mm) (25cm)**



REF 909014

Teeth are incorporated in a unique styled sharp jaw.

REF 907031 **Burke style (5.5mm x 3.25mm) (20cm)**



REF 907031

Two bottom teeth and one on the top maximizes the ability to grasp the cervix. Larger than Burke style punch.

REF 907032 **Baggish (6.5mm x 4mm) (20cm)**



REF 907032

Standard **20cm working length**
Long **25cm working length**

2 years
FREE
Sharpening

Additional designs:

Large rectangular bite with teeth for maximum sample.

REF 907028 **Tischler-Kevorkian (9.3mm x 3mm) (20cm)**

REF 907056 **Tischler-Kevorkian Punch (25cm)**

Narrow jaw with teeth on the bottom jaw improves grasping ability and prevents slippage.

REF 907029 **Kevorkian-Pacific style (8mm x 3mm) (20cm)**

REF 907057 **Kevorkian-Pacific style Punch (25cm)**

Large bite assures adequate sample for histological examination.

REF 907030 **Coppleson (7.5mm x 3mm) (20cm)**

Small bite size facilitates sampling of cervical os. Ideal for stenotic cervix.

REF 907033 **Sullivan Biopsy Punch (4mm x 2mm) (20cm)**

Serrated tooth on bottom jaw coupled with unique bite shape offers precision and control.

REF 907034 **Wittner Straight Standard (7.4mm x 3.9mm) (20cm)**

Large bite size and angled jaw improve access to difficult to reach areas of the cervix and provide adequate tissue sample.

REF 907035 **Wittner Angled Standard (4.4mm x 3.9mm) (20cm)**

Single anchoring tooth and V-shaped jaw facilitates sampling for analysis.

REF 907036 **Apex Standard style (7mm x 3mm) (20cm)**

Oval cutting jaw provides large tissue sample for analysis.

REF 907037 **Eppendorfer Standard (7.4mm x 3.9mm) (20cm)**



Rotating Biopsy Punches

360° rotating shaft permits taking biopsies at any angle without obstructing the biopsy site

Minimal trauma and maximum sample retention is provided by this most popular bite design.

REF 907004 **Tischler Rotating Biopsy Forceps (7mm x 3mm) (20cm)**

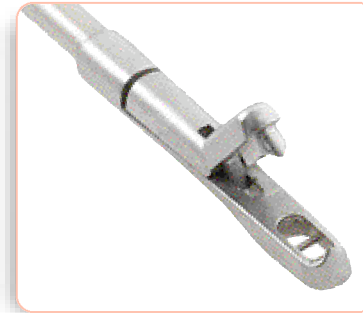

Angled tip facilitates sampling by permitting easier access to difficult areas. Enhances grasping ability.

REF 907019 **Angled Tischler Rotating Biopsy Forceps (7mm x 3mm) (20cm)**



Baby Tischler tip is small enough to permit sampling at the endocervical canal while providing excellent control.

REF 907059 **Rotating Baby Tischler Punch (4.2mm x 2.3mm) (25cm)**



An ample, well oriented sample is provided by the large rectangular bite.

REF 907060 **Rotating Kevorkian Punch (8mm x 3mm) (25cm)**



Reduced tissue trauma. Smaller size enables sampling of the cervical os in some patients.

REF 907038 **Mini-Townsend style Tip (4.2mm x 2.3mm) (20cm)**



Standard **20cm working length**
 Long **25cm working length**



Facilitates sampling of the cervical os and the outer periphery of the ectocervix

REF 907039 **Mini-Down Tip (4.2mm x 2.3mm) (20cm)**



Offers improved grasping ability. Prevents slippage of the cervix.

REF 907040 **Kevorkian Tip (8mm x 3mm) (20cm)**



Moderate bite for reduced trauma.

REF 907041 **Oval Tip (5mm x 3mm) (20cm)**



Smaller size enables sampling of the cervical os in some patients. Permits access to difficult areas.

REF 907042 **Mini Up Tip (4.2mm x 2.3mm) (20cm)**

2 years
FREE
 Sharpening



Curettes

Craftsmanship and dependability – for the physician who demands the finest surgical and biopsy instruments, the smart choice is Wallach

Round graduated tip offers ease of entry into a stenotic os or a nulliparous patient. Malleable shaft facilitates sampling.

REF 907021 **Townsend-style Curette**



Novak Curettes

Most popular curette samples endometrium. Suction attachment offers improved sampling.

REF 907022-1	1mm
REF 907022-2	2mm
REF 907022-3	3mm
REF 907022-4	4mm



For even sampling, this rounded, tapered tip allows easy entry with less tissue trauma.



REF 907023
REF 907027



**London-style Curette
Curette w/Basket Round Tip**

Kevorkian-Young

Sharp stainless steel blade available with and without basket.



REF 907005 **Kevorkian-Young Tissue Curette with Basket
(12mm x 1.9mm)**



REF 907006 **Kevorkian-Young Tissue Curette without Basket
(12mm x 1.9mm)**

Hooks

Stabilizes the cervix during sampling.

REF 907024 **Corkscrew Hook**



Small hook used to stabilize cervix.

REF 907025 **Iris Hook, Uncoated**



Offers superior view of cervix due to improved angle.

REF 907026 **Angle Hook**



Versatile in use and larger than the Iris Hook.

REF 907007 **Gyn Hook, Uncoated**



Cervical Dilators and Sounds

Dilators to fit your every patient need because your patients don't come in one size

Centimeter markings for precise sounding.

REF 907048

Sims Sound Grad 12"



Designed for smaller patients or those with a stenotic cervical os. Set includes 6 dilators from 1mm to 6mm in size.

REF 907049

Small Dilators – Set of 6



Designed for nulliparous patients or the stenotic cervical os. A universal handle and 5 tips ranging in size from 1mm to 3mm are included.

REF 907050

Mini-Dilator Set I – 3mm



Double ended, hollow dilators. German stainless steel. Set of 8 includes: 3/4mm, 5/6mm, 7/8mm, 9/10mm, 13/14mm, 15/16mm, 17/18mm

REF 907051

Hegar Dilator Set of 8 (3/4 – 17/18)



Stainless steel, double-ended dilators range in size from 4.5mm to 10mm.

Complete with full millimeter and half millimeter size.

REF 907052

Hank Dilator – Set of 6



Assisted Reproduction

The Inseminator™ – Intrauterine Insemination Device

This versatile intrauterine insemination device bypasses the cervix and allows a greater number of sperm to reach the uterine cavity and subsequently the fallopian tubes. The 3.5 French polypropylene catheter, enlarged in the proximal area to accommodate the syringe tip, comes in 4.5" or 5.5" length. The 4.5" may be purchased without syringe. The secure fit prevents leakage.

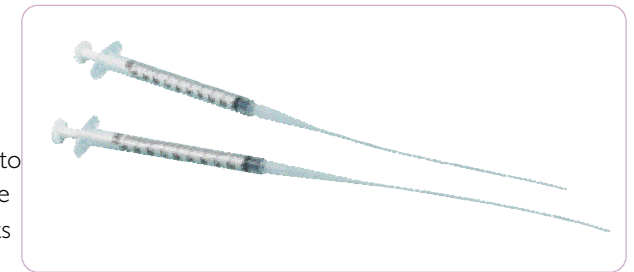

REF 920012

REF 920012-1

REF 920012-2

The Inseminator 5.5" (50 per box, sterile)

The Inseminator 4.5" (50 per box, sterile)

The Inseminator 4.5" w/o syringe (50 per box, sterile)

Cervical Mucous Syringe – For collection of cervical mucosal lining, post coital testing, external os or vaginal pool sampling.

- Flexible suction
- Plunger length 9"
- 2.6mm OD



REF 920004-1

Cervical Mucous Syringe (box of 50, non-sterile)

Single Use Products to Meet Your Needs



Disposable Os Finders – 3 convenient sizes in a sterile pouch

- Os Finder (single notch) locates and opens external os
- Canal Finder (two notches) dilates the cervical canal
- Fundus Finder (three notches) sounds fundus and determines uterine depth



REF 920019

Os Finder Set of 3 (10 sets per box, sterile)

Flexisound™ Intrauterine Sound

- Sterile, single-use only
- Gentle but firm, plastic malleable sound
- Graduated in centimeters
- Economical

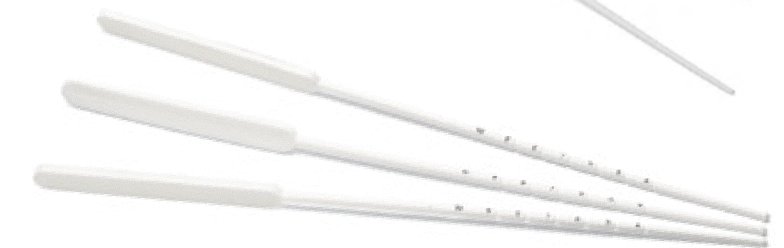

REF 920008

Flexisound (25 per box, sterile)

Disposable Vaginal Speculum – Designed for routine gyn exams

- Non-sterile, single-use only
- 360° view
- Angular and vertical adjustments
- One hand operation
- Smooth, comfortable, clear plastic



REF 920018

Disposable Vaginal Speculum, small (2 boxes of 100, non-sterile)

REF 920010

Disposable Vaginal Speculum, medium (2 boxes of 100, non-sterile)

REF 920020

Disposable Vaginal Speculum, large (2 boxes of 100, non-sterile)

Papette® Cervical Cell Collector

Wallach's Papette Cervical Cell Collector – ideal for conventional or fluid-based pap smear technology

In one simple step, Papette can gather the full spectrum of cervical cells including the transformation zone in a single rotating motion, eliminating the two-step brush and spatula combination. For the newer fluid-based technology, Papette can provide a highly efficient sampling of cells that will help this methodology deliver pap test readings of unparalleled accuracy. Papette is the logical choice in cervical cell collection devices.

- Higher overall cell yield improves Pap test accuracy
- Full spectrum sample includes the transformation zone
- Reduces false negatives and retesting
- Faster conclusive results improves prognosis
- Less bleeding for patient
- Simplified, one-step procedure for physician (simultaneous harvesting of ectocervical and endocervical cells)
- Unique, softer LDPE bristles with slip agent
- Extremely cost-efficient
- Gentle, rounded bristles of varying lengths



- REF 908001 **Papette** (bag of 100)
 REF 908003 **Papette** (10 packages per box; 1000 pieces)
 REF 908004 **Papette** (40 packages per box; 4000 pieces)

Ask about
our sterile
pouched
Papette!



better results – little or no bleeding

Endocell™ Disposable Endometrial Cell Sampler

Endometrial sampling with simplicity, safety and economy

The Wallach Endocell offers simplicity, safety and economy to the screening process for endometrial carcinoma and precancerous conditions. Using manual suction, it extracts a histological sample from the uterine mucosal lining in seconds. It is also an excellent monitor for the effects of hormonal therapy and a valuable diagnostic tool for fertility problems and uterine pathogens. It can be utilized for endometrial biopsy, suction type and menstrual extraction.

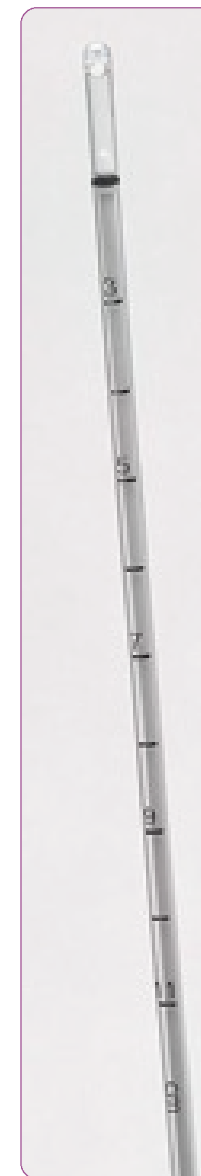

- Moldability permits easy insertion into a markedly anteverted or retroverted uterus
- Simple, non-traumatic procedure
- Less discomfort, bleeding, tissue abrasion than D & C method
- Excellent suction provided by elastomeric seal piston plunger
- No cervical dilation necessary in most cases
- Numbered sounding marks for safety, precision
- Each sampler is sterilized and individually packaged for convenience
- 3.1mm outside diameter
- Satisfaction guaranteed; return unused Endocell in original box for full refund



- REF 908014 **Endocell**
(Box of 35, sterile)
- REF 908015 **Endocell**
(6 boxes of 35 or 210 pieces, sterile)
- REF 908016 **Endocell**
(15 boxes of 35 or 525 pieces, sterile)
- REF 908018 **Endometrial Biopsy**
(Endocell) Videotape

Wallach's Endocell is the endometrial cell sampler of choice in my office. Excellent patient acceptance assures a rapid, simple technique. I find its moldability facilitates easy entry into the cervix. The product is consistently reliable.



Mark Storch, M.D.
Obstetrics/Gynecology
Westport, CT



Sonicaid Team™ (Series) Fetal Monitors

Fetal monitors offer maximum flexibility and ease of use.

The Sonicaid Team series is designed for simplicity in fetal monitoring. The units are small, easy to use and lightweight and can be transported effortlessly within hospitals, to clinics, doctor's offices or even the home. The Team range offers new PC interface for trace storage and analysis. Featuring a six-hour trace memory with fast print, the unit has a large graphic display providing clear monitoring at a glance. Color-coded transducers make setup easy. Remote monitoring is possible. Paper is easy to load.

Exclusive: now with Care Option – Fetal trace analysis included

- Compact and lightweight
- Twin fetal heart rate scales; avoid difficulty of interpreting offset or overlapping traces
- Easy to use menu system allows fast access to important functions
- Modem and network connections for remote and integrated obstetric management
- Graphical display showing on-screen FHR and Toco traces continuously updated



- REF 902001 **Team – Antepartum Singleton Monitoring**
 REF 902002 **Team Duo – Antepartum Monitoring for Twins**
 REF 902009 **Team IP – Basic Intrapartum Monitoring**

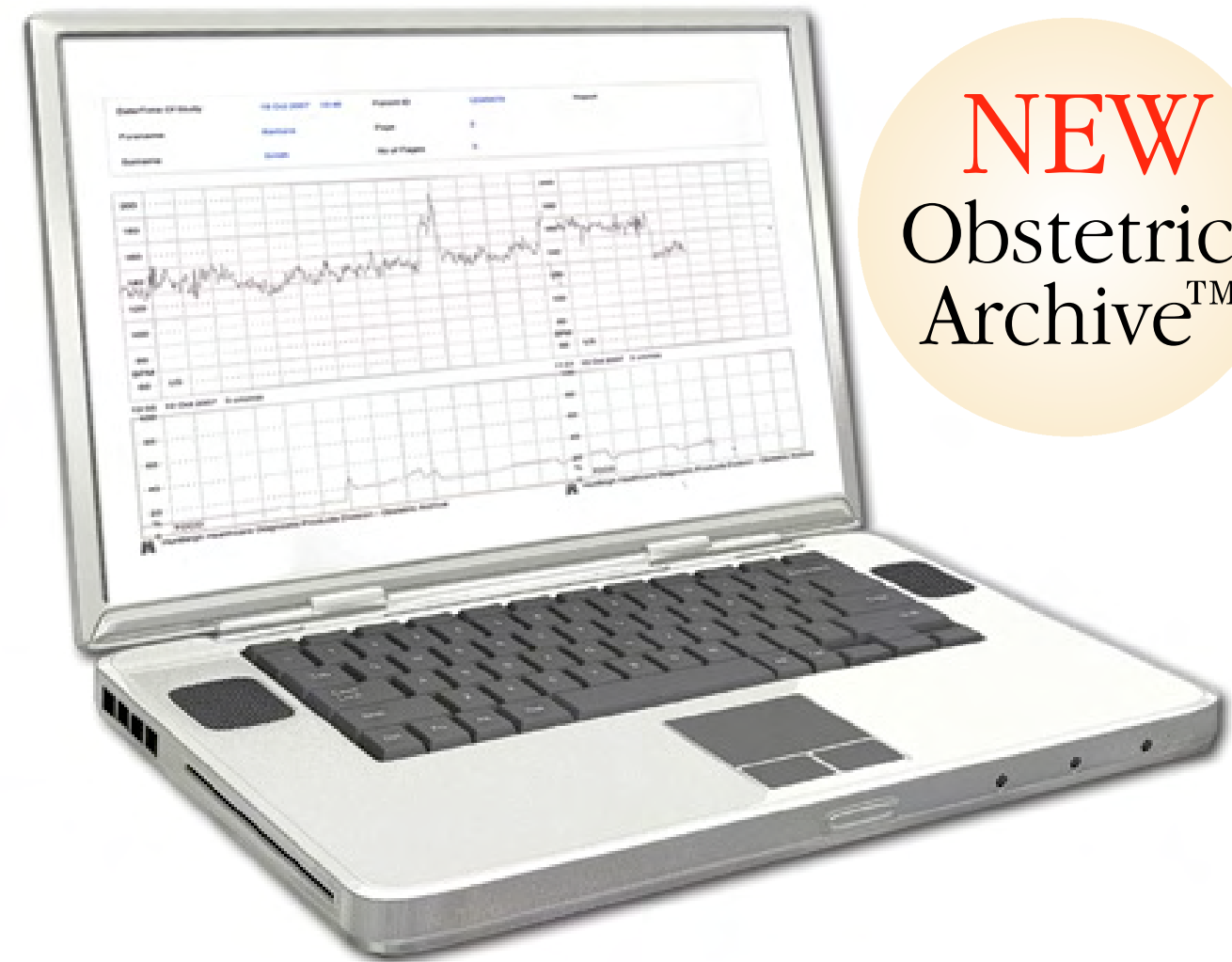

NEW
Obstetrics
Archive™

Digital Fetal Monitoring

*Electronic NST viewing and archiving
 for use in conjunction with Sonicaid Fetal Monitors*

- Find every trace with the click of the mouse
- Transfer files to your EMR systems through PDF
- Simple and easy to use
- Call for a free demonstration 1-800-243-2463 ext.153
www.wallachsurgical.com

REF 902016 **Obstetrics Archive Software**

Obstetrics Archive is an MS Windows™ based software package designed to operate on Windows 2000™ or Windows XP™ operating systems

For use exclusively with Sonicaid Team™ Fetal Monitors

SonicaidOne™ Fetal Heart Doppler

Advanced technology increases performance and reliability

Detect fetal heart rate quickly and easily from early gestation through labor and delivery with Wallach's SonicaidOne Fetal Doppler. The unit is so small and lightweight that it's easy to transport and store. It's simple to use and it's comfortable to hold. One model meets every requirement. Higher sensitivity with wider beam coverage enables location of heart signals quickly from early gestation to full term. Fetal heart sounds are heard in excellent clarity and the large, reflective display can be easily read. The recessed buttons and "memory" volume control add to the unique styling and work-friendly ergonomics to create the ultimate in ease of use. Over 1000 one-minute examinations per 2 "AA" batteries means there is no fetal heart detector with better economy.

- Unique design
- Easy to use
- Waterproof probe as standard
- Fetal heart rate display
- Lower running costs

REF 902000 **SonicaidOne Fetal Doppler**



The SonicaidOne comes complete with soft pouch, gel, batteries, user guide, pregnancy calculator and pen.



UltraFreeze™ Liquid Nitrogen Cryosurgical System

New Smooth Flow Spray Technology

The compact, lightweight UltraFreeze is the new, easy-to-use, portable cryosurgical system ideal for most office skin procedures. The newly designed ergonomic handle offers comfort and control. Completely self-contained, the system delivers controlled spray. UltraFreeze is supplied with an assortment of easily attached luer lock closed tip or open apertures.

- Available in two sizes (.3 and .5 liter)
- Ergonomically designed comfort handle
- Smooth flow spray technology
- Enhanced performance
- Spray apertures offer precision accuracy of liquid nitrogen spray for better control
- Uniform pattern on skin
- Three year warranty

AccuShield

Plastic reusable plate with 6 conical openings. Helps to direct liquid nitrogen spray in a concentrated area.



- | | |
|------------|--|
| REF 900076 | UltraFreeze (.5 liter) with 5 spray apertures |
| REF 900077 | UltraFreeze (.3 liter) with 5 spray apertures |
| REF 900108 | AccuShield (set of 6 varied cones) |
| REF 900112 | UltraFreeze Stand |

Assortment of spray apertures included (Flat, closed tips available)



To order, call • 1-800-243-2463 • www.wallachsurgical.com

Warranty Information

Instrument	Duration
LL100 Freezer	5 Years* (see below)
Cryosurgical Consoles & Probes	1 Year
UltraFreeze	3 Years
Colposcopes and Microscopes	3 Years
Colposcope Smart Package/Trulight	7 Years
Digital Imaging Systems	1 Year
Video Accessories	1 Year
Electrosurgical Generator and Integration Unit	1 Year
Smoke Evacuators	1 Year
Biopsy Instruments	1 Year
Sonicaid Fetal Doppler	1 Year
Sonicaid Fetal Monitors	1 Year
Sunlight Bone Densitometers	1 Year
Hand-held Instruments	1 Year

Wallach products are warranted by Wallach Surgical Devices to be free from defects in material and workmanship for the period indicated above. During this period, Wallach Surgical Devices or its authorized service station will, at its option and without charge, either repair or replace any part or assembly of parts found to be defective in material and workmanship. Repairs are to be accomplished by a Certified Wallach Surgical Devices Repair Technician. In the event that the unit is tampered with by unauthorized personnel prior to the end of the warranty, the warranty is considered NULL and VOID.

Wallach Surgical Devices is not responsible for any injury resulting from repairs made by other individuals or organizations not certified by Wallach Surgical Devices.

This warranty does not apply to the following:

- Product which has been subject to misuse, abuse, negligence or accident.
- Defects or damage directly or indirectly caused by installation or service of the product by unauthorized personnel and/or the use of unauthorized replacement parts.
- Lamps, bulbs, fiber optic cables and batteries.
- Improper use of cleaning methods or chemicals which damages equipment.
- Peripheral equipment that is covered by the manufacturer's warranty.

* The LL100 carries a 5 year warranty as follows: one year unconditional plus four year warranty against defects and workmanship, excluding items in need of repair or replacement due to normal wear and use, and limited per above. In case of freezer malfunction, immediately turn gas cylinder master valve completely "OFF" and detach instrument from gas cylinder.

All Wallach products are Latex Free with the exception of the Lidocaine anesthetic which may contain Latex or natural rubber proteins in the cartridge stoppers.

Return Goods Policy

- Product may be returned to Wallach under the following circumstances:
 - If incorrect items were shipped
 - If defective items were shipped (out of box failure)
- To return product, contact a customer service representative to obtain an RGA (Return Goods Authorization) number. Be prepared to give the following information:
 - The date the item was ordered
 - The Wallach invoice number and billing name and address
 - Reason for the return
 - Quantity, part number, description, and serial number of the merchandise to be returned
- Goods must be returned unused. Any charges for damage or missing items will be added to the restocking fee.
- Only prepaid shipments will be accepted from the customer. Return collect merchandise will be refused.
- Product should be securely packaged in the original carton. Equipment must be sanitized before it is returned. Items that are not sanitized will be returned to the customer freight collect. All shipments must be made via pre-paid parcel post or U.S. Mail. C.O.D. packages will not be accepted.
- Sterile and disposable products, as well as light bulbs are not returnable.
- The following restocking charges will apply to product ordered in error:

5%	1 – 30 days
10%	31 - 60 days
15%	61 – 90 days

 Goods must be returned unused in original condition. Returns will not be accepted after 90 days.
- Tips may be returned or exchanged within 30 days. Tips that are damaged or scratched are not returnable. Care should be taken in packaging tips individually.

ALL PRICES IN THIS CATALOG ARE SUBJECT TO CHANGE WITHOUT NOTICE.

Repair Policy

- Repairs are to be accomplished by a certified Wallach Surgical Devices Repair Technician.
- Wallach does not perform partial instrument repairs due to patient and Physician safety factors.
- To return product for repair, call the repair department. Be prepared to provide the following information:
 - Product description
 - Serial number
 - Statement of the problem
- Repairs should be handled through the dealer whenever possible.
- The repair technician will provide an estimate for customer approval before any repairs occur.
- If the customer does not choose to repair the item after receiving the estimate, a \$45.00 evaluation charge will be assessed.
- Equipment must be sanitized before it is returned for repair. Items that are not sanitized will be returned to the customer freight collect.
- To return instrument for service carefully package the instrument in a container of adequate size and strength. Clearly mark the outside of the box "Attn. Repair Department." Return Postage PAID via United Parcel Service or U.S. Postal Service together with a note describing the problem. DO NOT RETURN GAS CYLINDERS. C.O.D. packages will not be accepted.

Repairs may be sent to:

Wallach Surgical Devices
95 Corporate Drive
Trumbull, CT 06611

Index

Angle Hook	23	Digital Colposcope	6, 7	Ferric Sub sulfate Solution	13
Assisted Reproduction		Digital Imaging		Fetal Monitors	
The Inseminator	25	(see <i>Digital Colposcope</i>)		SonicaidOne Fetal Doppler	32
Cervical Mucous Syringe	25	Dilators		Sonicaid Team Fetal Monitors	30
Astringent		Hank Cervical Dilator Set	24	Sonicaid FM800 series	30
Ferric Sub sulfate Solution	13	Hegar Dilator Set	24	Obstetrics Archive	31
Ball Electrode	11	Mini Cervical Dilator Set	24	Graves Specula (see <i>Specula</i>)	
Biopsy Punches		Small Cervical Dilator Set	24	Hooks	
Apex Standard Style	19	Disposable Products I I-13, 25-27		Angle Hooks	23
Baby Tischler	18	Disposable Specula	25	Iris Hook	23
Baggish	18	Electrodes (see <i>Electrosurgery</i>)		Corkscrew Hook	23
Burke	18	Electrosurgery		Liquid Nitrogen Sprayer	
Coppleson	19	Quantum 2000 System	10	UltraFreeze	33
Eppendorfer	19	Accessories		Loop Electrodes	
Kevorkian	19	Cable for grounding pads	12	(see <i>Electrosurgery</i>)	
Kevorkian-Pacific Style	19	Cartridge Syringe	13	Monser's Solution (see <i>Ferric</i>	
Sullivan	19	Electrodes – loop, ball, needle,	11	<i>Sub sulfate astringent</i>)	13
Tischler	18	square		Needles	13
Tischler-Kevorkian	19	EndoBlock Kit	12	Cartridge Syringe	13
Wittner, Angled/Straight	19	EndoBlock Needles	13	Luer Lok Needles	13
Biopsy Punches, Rotating		Ferric Sub sulfate Solution	13	Threaded Hub Needles	13
Angled Tischler	20	Grounding Pad, (split)	12	Os Finder	25
Kevorkian Tip	21	single use with connect		Pap Smear Brush	26
Mini Down Tip	21	Grounding Pad (split)	12	Retractors	
Mini-Townsend Tip	20	single use with reusable cable		Lateral Vaginal Retractor, coated	15
Mini Up Tip	21	Handpiece, Single Use	12	Lateral Vaginal Retractor,	17
Oval Tip	21	Lletz Procedure Tray	13	uncoated	
Rotating Baby Tischler	20	Loop Electrodes	11	Smoke Evacuator	
Rotating Kevorkian	20	Smoke Evacuator Filter	13	Biovac	10
Tischler Rotating	20	Smoke Evacuator Tubing	13	Smoke Evacuator	13
Bone Densitometry		Specula – coated (see <i>Specula</i>)		Tubing/Filter	
Sunlight Omnisense 7000S	28	Electrosurgical Instruments		Specula, coated	
Sunlight Omnisense 8000S	29	Forceps		Graves	15
Cervical Cell Collector		Campion Forceps	14	Omni Speculum 4-blade	15
Papette	26	Ring Forceps	14	Pederson	15
Colposcopy		Single Tooth Tenaculum	14	Ultimate Reusable	15
ColpoStar IH	5	Tissue Forceps	14	View-Maxi	15
Digital Camera	5	Hooks		View-More	15
PentaScope	4	Coated Gyn Hook	14	Specula Dimensions	16
PentaStar	5	Iris Hook	14	Specula, plastic	
TriScope	4	Two-Prong Hook	14	Disposable Specula	25
TriStar	5	Three-Prong Hook	14	Specula, uncoated	
Video Camera	7	Leep Hook, Straight, Right, Left	14	Graves	17
Video Colposcope	6	Endocervical Block Kit	12	Kogan Endocervical	17
ZoomScope with Trulight	2	Endocervical Block Needle	13	Omni Speculum 4 Blade	17
ZoomStar with Trulight	3	Endocervical Curettes	22	Pederson	17
Cryosurgery		(stainless)		View-Maxi	17
Cart	8	Kevorkian-Young Curette	22	View-More	17
Cryosurgical Tips	9	London style Curette	22	Weisman	17
LL100 Cryosurgical System	8	Townsend style Curette	22	Teaching Tube	5
Tank	8	Endocervical Sampling		Tubing	13
UltraFreeze	33	(see <i>Endocervical Curette</i>)		Uterine Sounds	24, 25
Liquid Nitrogen Sprayer		Endocervical Specula	17	Video Colposcope	6
WA1000B Console System	8	Endometrial Sampling			
Curettes/Hooks	22, 23	Endocell	27		
Customer Service		Endometrial Curettes			
Return Goods Policy	34	Novak Curette	22		
Warranty Information	34	Endocell	27		
Repair Policy	34				

1-800-243-2463
www.wallachsurgical.com



WALLACH

Wallach Surgical Devices
Trumbull, CT 06611